



SWIPE TO SEE THE VIDEO

扫一扫看视频

ARCHITECTURAL DOOR HANDLES

建筑门把手



BOLS 博洛斯®

温州市博洛斯五金有限公司
Wenzhou Bolos Hardware Co., LTD

地址:中国温州龙湾滨海工业园区滨海四道820号
Add: No. 820, Binhai 4th Road, Binhai Industrial Park, Longwan District, Wenzhou, China

TEL/电话: 86-577-86610066

Fax/传真: 86-577-86627655

Email/邮箱: bols@bolslock.com

www.bolslock.com

BOLS 博洛斯®

BOLS 博洛斯®

温州市博洛斯五金
是一家集研发、生产、销售、服务于
一体的高中档门锁制造企业，
主要生产球形锁、执手锁、三杆锁、锁芯、锁体等产品，
有着三十年五金制锁经验，
公司本着“装扮人间、亮丽生活”的宗旨，
以产品质量上乘，造型新颖、良好的售后服务，
畅销全国各大城市及欧盟、中东以及日本、美国等，
在消费者当中享有较高的地位。

根据客户的要求设计生产指定产品，客户的满意，
就是博洛斯五金锁业永远执着追求的终极目标。

我们真诚期待着与您的合作!

Wenzhou Bolos Hardware

It is a company integrating R&D, production, sales and service

An integrated high and mid-range door lock manufacturing enterprise

Mainly produce spherical locks, handle locks, three-bar locks, lock cores, lock bodies and other products

With 30 years of experience in making hardware locks

The company adheres to the tenet of "Adorning the world and brightening life"

With superior product quality, novel design and excellent after-sales service

It sells well in major cities across the country as well as in the European Union, the Middle East, Japan, the United States, etc.

It enjoys a relatively high status among consumers.

Design and produce the designated products according to the customer's requirements, ensuring customer satisfaction.

It is the ultimate goal that Bolos Hardware Lock Industry has always been persistently pursuing.

We sincerely look forward to cooperating with you!



BOLS 博洛斯®



Light Luxury, Simple And High Taste

Simple lines make smooth reading, the subtle but did not forget to design, simple fashion the take in everything in a glance.



The Crystallization
Of Inspiration And Creativity



■ Create a
high-quality brand

THE SOUL
OF VISUAL ART
SPACE

CATALOGUE 目录

Ball Lock Serie 球形锁系列	01
Triple Lock Serie 三杆锁系列	06
Villa Lock Serie 别墅锁系列	11
Zinc Alloy Serie 锌合金系列	14
Pure Copper Serie 纯铜系列	39
Stainless Steel Serie 不锈钢系列	52
Ecological Doorlock Serie 生态门锁系列	57
Hydraulic Hinge Serie 液压合页系列	69
Lock Body/lock Core Serie 锁体/锁芯系列	73
Hinge Serie 合页系列	82
Floor Suction/door Suction Serie 地吸\门吸系列	85

BALL LOCK Serie

球形锁系列



BALL LOCK SERIE

球形锁系列



587-TM/GP



587-BL



587-AC-BK



587-SS



587-TM/SB-BK



587-GP



587-AB



5831-TM/SB



5831-GP



5831-TM/SB



5831-SN



5831-TML/GP



5831-AC



578-AC



578-AB



578-TM/GP



578-MSN



588-AC



588-AB



588-SS



588-GP



588-TM



891-AC



891-AB

BALL LOCK SERIE
球形锁系列



891-MSN



891-MAB



5791-AC



5791-AB



5791-SS



5791-S/SS



5900-AC



5900-AB



5899-AC



5899-AB



9200-G



9200-W



890-AC/BN



893-AB/BN



893-AC/BN



894-AB/BN



895-AC/BN



897-AC/BN



586-AC



589-AC



5731-S/SS



5831-AC



5731-AB



5799-AC/BN

BALL LOCK SERIE
球形锁系列



5871-AC/BN



5872-AC/BN



5795-AC/BN



5796-AC/BN



5797-AC/BN



5798-AC/BN



5793-AC/BN



5874-AC/BN



607-AC-BK



607-BG-ET



607-MAB-BK



607-AB-ET



607-CP-ET



607-SS-BK



607-SB-PS



607-PB-ET



607-BL-ET



607-WH-ET



607-WF-ET



607-WD-ET



D101-GP



D102-CP



D101-AB



D102-SN

BALL LOCK SERIE
球形锁系列



607-WL-ET



607-WE-ET



772CP-ET



772SN-ET



772BL-ET



772CP-BK



772SN-BK



772BL-BK



772CP-PS



772SN-PS



772BL-PS



BM520-Chrome



530-DZML-orange



530-DZML-Black



530-DZML-Brown



BM520-Black



MB587-PVD-ET



MB587-SS-ET



MB587-BL-ET



MB587-AB-ET



8304-SS-BK



8304-PVD-SR



8304-SS-ET



8304-BL-ET

TRIPLE LOCK Serie

三杆锁系列



TRIPLE LOCK SERIE
三杆锁系列



200-4-CP-PS



200-4-SB-ET



200-4-PB-ET



200-4-AB-BK



200-4-SN-ET



200-2-PB-PS



200-2-AB-ET



200-2-MAB-PS



200-2-AC-BK



200-2-CP-BK



200-2-SN-BK



200-7-MAB-BK



200-7-CP-BK



200-7-PB-ET



200-7-SN-ET



200-7-AB-ET



200-15-AC-BK



200-15-AB-ET



200-15-SN-BK



200-15-GP-ET

TRIPLE LOCK SERIE
三杆锁系列



6010-PB-BK



6010-SN-ET



6010-CP-BK



6010-AB-ET



6010-BL-BK



6020-AB-BK



6020-MAB-PS



6020-BL-ET



6020-AC-ET



6020-SB-BK



6020-CP-PS



6020-BG-ET



6020-PB-BK



6020-SN-ET



6024-AC-ET



6024-AB-PS



6024-PB-PS



6024-CP-BK



6024-SN-BK



6026-AC-ET

TRIPLE LOCK SERIE
三杆锁系列



6026-PB-ET



6026-CP-BK



6026-SN-PS



6026-AB-BK



6030-MAB-ET



6030-PB-ET



6030-SB-PS



6030-AB-PS



6030-AC-ET



6030-SN-BK



6033-AC-PS



6033-SN-ET



6033-AB-BK



6033-MAB-ET



6037-AC-BK



6037-AB-ET



6037-CP-PS



6037-SN-ET



6037-PB-BK

TRIPLE LOCK SERIE
三杆锁系列



710CP-PS



710SN-PS



710BL-PS



710BL-BK



710CP-BK



710SN-BK



710BL-ET



710SN-ET



710CP-ET



M882AC-ET



M882AB-ET



M862SN-ET



M872BL-ET



M882SN-ET



X101-BL-ET



X101-BG-ET



X103-BL-ET



X208-AB-ET



571L-BL-ET



L208-BL-BK



571L-SN-ET



571L-AB-ET



671L-SS-ET



L8003-AC



L8003-AB



L8004-AC



L8004-AB



L8005-AC



L8005-BL



L8005-SN



L8005-AB



L8006-AC



L8006-BL



L8006-SN



L8006-AB



L8007-AC



L8007-BL



L8007-SN



L8007-AB



COTTAGES Serie
別墅鎖系列

VILLA LOCK SERIES
別墅鎖系列



L8002-AC



L8002-SN



L8002-AB



L8001-BL



L8001-AC



L8001-SN



L8001-AB



L8001-PB



L8001-BG



L8007+904 DM



L8006+906 ZML



L8005+907 DM



904 DM



905 DM



906 ZML



907 DM

ZINC ALLOY SPLIT SERIES
鋅合金分體系列

LJ39-L12 CGB

Material: Zinc alloy

Design drawings:

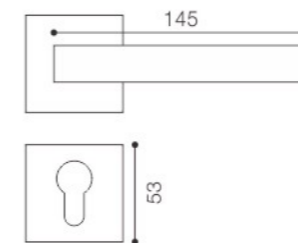

H39-L12 MBL

Material: Zinc alloy



LJ38-L12 BNM

Material: Zinc alloy



LJ38-L12 SC

Material: Zinc alloy



L255-L54 PCB

Material: Zinc alloy



L255-L54 CP

Material: Zinc alloy



L255-L12 PCB

Material: Zinc alloy



M60-L12 SN

Material: Zinc alloy



M60-L12 PCB

Material: Zinc alloy



L118-L51 SC

Material: Zinc alloy



L242-L12 PCB

Material: Zinc alloy



L242-L12 SN

Material: Zinc alloy



L118-L12 BNM

Material: Zinc alloy



ZINC ALLOY SPLIT SERIES
锌合金分体系列

LAM39-L12 BL
Material: Zinc alloy

Design drawings:

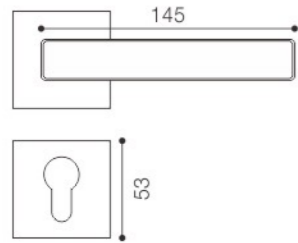

ZINC ALLOY SPLIT SERIES
锌合金分体系列

H27-L12 PCB
Material: Zinc alloy

Design drawings:

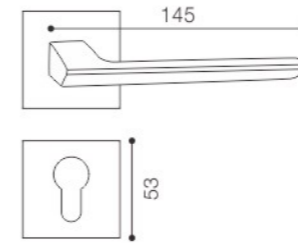

T36-L12 PCB
Material: Zinc alloy



A49-L12 SN
Material: Zinc alloy



A49-L12 MSC
Material: Zinc alloy



X33-X147 CP
Material: Zinc alloy



X835-28 AB
Material: Zinc alloy



LY18-518 CP
Material: Zinc alloy



LJ39-L12 SN
Material: Zinc alloy



LJ39-L12 BL
Material: Zinc alloy



LJ39-L12 CGB
Material: Zinc alloy

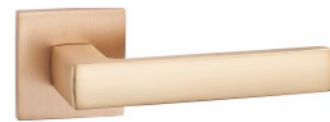

A01-26 PCB
Material: Zinc alloy



LY18-519 SBL/G
Material: Zinc alloy



X835-58 BSN
Material: Zinc alloy



LJ39-L12 GAG
Material: Zinc alloy



F8-6601 SN
Material: Zinc alloy



F8-6601 SB
Material: Zinc alloy



L12-241 CGB
Material: Zinc alloy

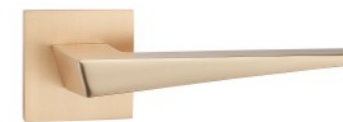

L12-241 BL
Material: Zinc alloy



L12-241 WH
Material: Zinc alloy



X33-X96 BSN
Material: Zinc alloy



X853-52 SN
Material: Zinc alloy



X33-X713 BSN
Material: Zinc alloy

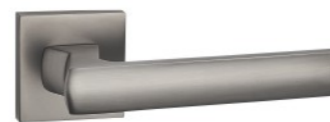

L169-L12 PCB
Material: Zinc alloy



L254-L12 PCB
Material: Zinc alloy



L88-L12 SC
Material: Zinc alloy



ZINC ALLOY SPLIT SERIES
锌合金分体系列

L226-L12 BNM

Material: Zinc alloy

Design drawings:

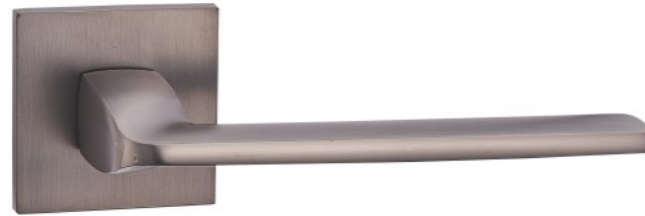
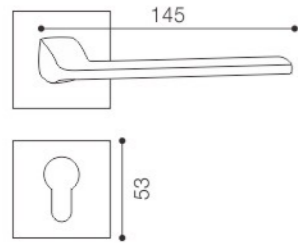

KL0521 BL

Material: Zinc alloy



L242-L12 BL

Material: Zinc alloy



X32-X715 MBL

Material: Zinc alloy



A62B-L12 PCB

Material: Zinc alloy



L30-L12 SN

Material: Zinc alloy



L171-L12 PCB

Material: Zinc alloy



L258-L12 PCB

Material: Zinc alloy



P5-L12 PCB

Material: Zinc alloy

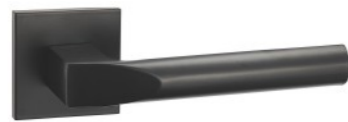

L66-L12 CP

Material: Zinc alloy



T35-X15 BBL

Material: Zinc alloy



T31-L14 CP

Material: Zinc alloy



T31-L14 BBL

Material: Zinc alloy



ZINC ALLOY SPLIT SERIES
锌合金分体系列

L2-6500 AB

Material: Zinc alloy

Design drawings:

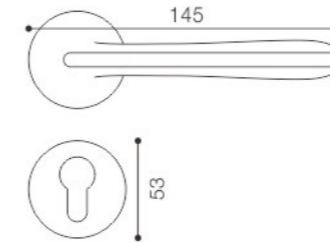

L2-6500 MBL

Material: Zinc alloy



L2-6500 SB

Material: Zinc alloy



L2-6500 GAG

Material: Zinc alloy



FT03-42 SN

Material: Zinc alloy



FT03-42 BBL

Material: Zinc alloy



FT03-42 BL

Material: Zinc alloy



L2-800 24KBG/CR

Material: Zinc alloy



L2-610 PVD/MBL

Material: Zinc alloy



DY03-49 BL

Material: Zinc alloy



L2-800 CP/CR

Material: Zinc alloy



L2-610 CP/MBL

Material: Zinc alloy



DY03-49 BL

Material: Zinc alloy



ZINC ALLOY SPLIT SERIES
锌合金分体系列

X32-X716 MBL

Material: Zinc alloy

Design drawings:

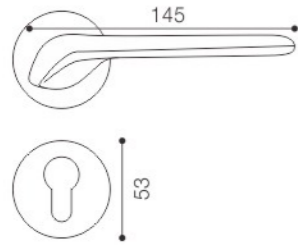

L2-669 MBL

Material: Zinc alloy



L2-769 YB

Material: Zinc alloy



L2-636 CP

Material: Zinc alloy



L2-669 AB

Material: Zinc alloy



L2-769 MBL

Material: Zinc alloy



L2-636 BL/AC

Material: Zinc alloy



L2-668 SB

Material: Zinc alloy



L2-708 BL/AC

Material: Zinc alloy



X32-715 GAG

Material: Zinc alloy



L2-668 MBL

Material: Zinc alloy



L2-708 AB

Material: Zinc alloy



X32-715 MBL

Material: Zinc alloy



ZINC ALLOY SPLIT SERIES
锌合金分体系列

X836-62 BL

Material: Zinc alloy

Design drawings:

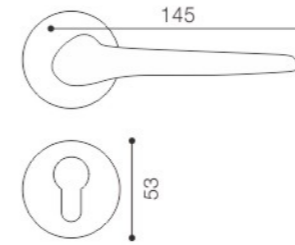

X836-62 GAG

Material: Zinc alloy



X836-62 YB

Material: Zinc alloy



X836-62 PVD

Material: Zinc alloy



FT03-18 BL

Material: Zinc alloy



FT03-18 BBL

Material: Zinc alloy



X32-X717 SG

Material: Zinc alloy



L2-678 SB

Material: Zinc alloy



L2-618 SB

Material: Zinc alloy



M65-C13 MBL

Material: Zinc alloy



L2-678 GAG

Material: Zinc alloy



L2-618 MBL

Material: Zinc alloy



L2-678 MBL

Material: Zinc alloy



ZINC ALLOY SPLIT SERIES
锌合金分体系列

L2-650 BL
Material: Zinc alloy

Design drawings:

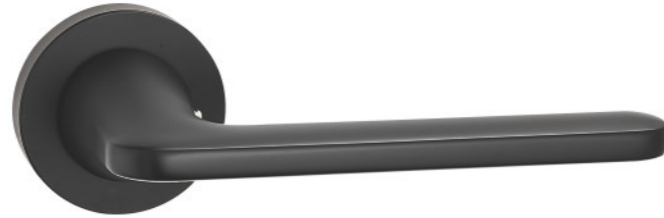
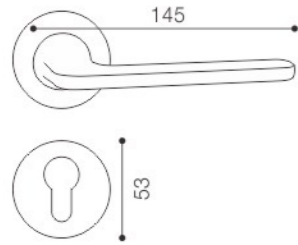

L2-650 GAG
Material: Zinc alloy



L2-650 YB
Material: Zinc alloy



L2-650 SN
Material: Zinc alloy



L2-650 AB
Material: Zinc alloy



L2-650 SB
Material: Zinc alloy



L2-650 CP
Material: Zinc alloy



DY03-58 AB
Material: Zinc alloy



DY03-58 PVD
Material: Zinc alloy



DY03-58 BL
Material: Zinc alloy



FT03-92 PVD
Material: Zinc alloy



FT03-92 CP
Material: Zinc alloy



FT03-92 BL
Material: Zinc alloy



ZINC ALLOY SPLIT SERIES
锌合金分体系列

JT001 BL
Material: Zinc alloy

Design drawings:

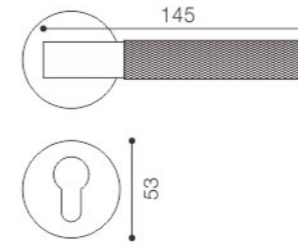

JT001 BROWN
Material: Zinc alloy



JT001 SG
Material: Zinc alloy



JT001 BBL
Material: Zinc alloy



JT001 SAN
Material: Zinc alloy



JT001 BL
Material: Zinc alloy



X03-T103 BL
Material: Zinc alloy



X836-68 BL
Material: Zinc alloy



X836-68 BBL
Material: Zinc alloy



G01-50 SB
Material: Zinc alloy



X32-X176 BSN
Material: Zinc alloy



X32-X738 GAG
Material: Zinc alloy



X32-X140 MBL
Material: Zinc alloy



ZINC ALLOY SPLIT SERIES
锌合金分体系列

JT002 AB
Material: Zinc alloy

Design drawings:

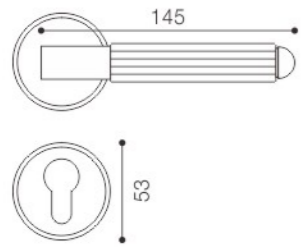

G03-L13 WH
Material: Zinc alloy



X03-T15 BL/SG
Material: Zinc alloy



JT002 YB
Material: Zinc alloy



JT002 BROWN
Material: Zinc alloy



JT003 AB
Material: Zinc alloy



JT003 YB
Material: Zinc alloy



L2-311 GAG
Material: Zinc alloy



L2-633 MBL
Material: Zinc alloy



L2-311 GAG
Material: Zinc alloy



L2-311 SB
Material: Zinc alloy



L2-633 GAG
Material: Zinc alloy



L2-311 SG
Material: Zinc alloy



ZINC ALLOY SPLIT SERIES
锌合金分体系列

L89-L13 BL
Material: Zinc alloy

Design drawings:

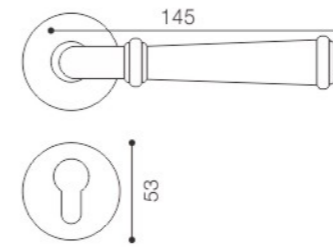

TL152 YB
Material: Zinc alloy



TL152 SB
Material: Zinc alloy



TL152 CP
Material: Zinc alloy



TL152 MBL
Material: Zinc alloy



TL152 AC
Material: Zinc alloy



TL152 GRAY
Material: Zinc alloy



F3-6321 PVD
Material: Zinc alloy



F3-6321 MBL
Material: Zinc alloy



L89-L13 PVD
Material: Zinc alloy



F3-6321 PVD
Material: Zinc alloy



F3-6321 CP
Material: Zinc alloy



L89-L13 YB
Material: Zinc alloy



ZINC ALLOY SPLIT SERIES
锌合金分体系列

TL153 PVD
Material: Zinc alloy

Design drawings:

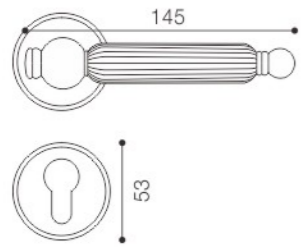

TL153 YB
Material: Zinc alloy



TL153 SB
Material: Zinc alloy



TL153 CP
Material: Zinc alloy



TL151 SB
Material: Zinc alloy



TL151 SG
Material: Zinc alloy



TL151 YB
Material: Zinc alloy



TL151 GRAY
Material: Zinc alloy



TL151 CP
Material: Zinc alloy



TL191 AB
Material: Zinc alloy



TL191 PVD
Material: Zinc alloy



TL191 YB
Material: Zinc alloy



TL191 SN
Material: Zinc alloy



ZINC ALLOY SPLIT SERIES
锌合金分体系列

FT03-73 CP/BLCR
Material: Zinc alloy

Design drawings:

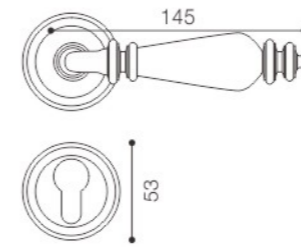

FT03-73 PVD/BCR
Material: Zinc alloy



FT03-73 CP/GCR
Material: Zinc alloy



FT03-73 CP/CQ
Material: Zinc alloy



FT03-75 CP/CQ
Material: Zinc alloy



FT03-77 PVD/CQ
Material: Zinc alloy



FT05-78 PVD/CQ
Material: Zinc alloy



FT03-76 CP/CQ
Material: Zinc alloy



FT03-07 WH/CE
Material: Zinc alloy



FT03-07 CP/CE
Material: Zinc alloy



FT03-07 CP/CE
Material: Zinc alloy



FT03-07 PVD/CE
Material: Zinc alloy



FT03-07 PVD/CE
Material: Zinc alloy



ZINC ALLOY SPLIT SERIES
锌合金分体系列

FT03-57 PVD

Material: Zinc alloy

Design drawings:

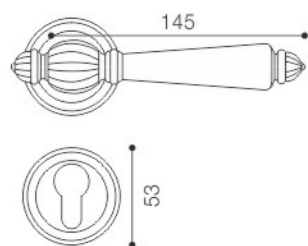

ZINC ALLOY SPLIT SERIES
锌合金分体系列

L2-698 GRAY/BWG

Material: Zinc alloy

Design drawings:

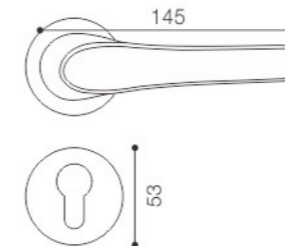

FT03-55 BL

Material: Zinc alloy



FT03-57 CP

Material: Zinc alloy



FT03-57 YB

Material: Zinc alloy



X32-X131 SN/WG

Material: Zinc alloy



X32-X132 WH/WG

Material: Zinc alloy



X301 CP/WA

Material: Zinc alloy



MT03-55 BG/WG

Material: Zinc alloy



MT03-55 WH/WG

Material: Zinc alloy



MT03-55 CP/WG

Material: Zinc alloy



X32-X131 SN

Material: Zinc alloy



X32-X132 AB/WG

Material: Zinc alloy



X301 YB/WA

Material: Zinc alloy



MT03-50 CP/Y

Material: Zinc alloy



MT03-50 CP/B

Material: Zinc alloy



MT03-50 PVD/R

Material: Zinc alloy



X32-X130 MBL/WG

Material: Zinc alloy



X32-X196 BSN+BRL

Material: Zinc alloy



X32-X111 MBL/WG

Material: Zinc alloy



MT03-50 CP/R

Material: Zinc alloy



MT03-50 CP/WG

Material: Zinc alloy



AX10-X162 MBL/BBL

Material: Zinc alloy



X32-X712 SG/BLL

Material: Zinc alloy



X32-X712 BL/BRL

Material: Zinc alloy



LY17-517 PB/BLL

Material: Zinc alloy



ZINC ALLOY SPLIT SERIES
锌合金分体系列

K0615 MBL

Material: Zinc alloy

Design drawings:

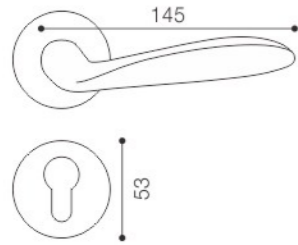

L2-7115 24K-BG

Material: Zinc alloy



1-5899 MBL

Material: Zinc alloy



1-585 BG

Material: Zinc alloy



L2-7115 MBL

Material: Zinc alloy



1-5899 WH

Material: Zinc alloy



1-585 WH

Material: Zinc alloy



1-581 BG

Material: Zinc alloy



1-1077 BG

Material: Zinc alloy



1-181 SB

Material: Zinc alloy



1-581 SB

Material: Zinc alloy



1-1077 SB

Material: Zinc alloy



1-181 MBL

Material: Zinc alloy



ZINC ALLOY SPLIT SERIES
锌合金分体系列

X32-X161 SG/BEL

Material: Zinc alloy

Design drawings:

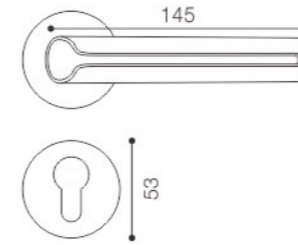

X32-173 BSN

Material: Zinc alloy



X836-65 BL

Material: Zinc alloy



X836-65 SN

Material: Zinc alloy



X835-66 BYB

Material: Zinc alloy



X836-65 BL+BRL

Material: Zinc alloy



X836-65 BL+BLL

Material: Zinc alloy



X32-X139 MBL

Material: Zinc alloy



X32-X149 BSN

Material: Zinc alloy



X32-X160 MBL

Material: Zinc alloy



X32-X100 GAG

Material: Zinc alloy



X32-X714 PVD

Material: Zinc alloy



X32-X148 BSN

Material: Zinc alloy



ZINC ALLOY SPLIT SERIES
锌合金分体系列

L070-X50 PCB

Material: Zinc alloy

Design drawings:

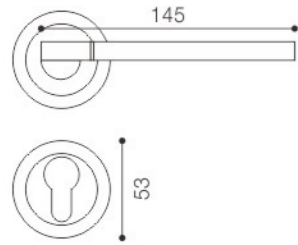

KL0607 BL

Material: Zinc alloy



KL0620 BL

Material: Zinc alloy



KL0618 BL

Material: Zinc alloy



KL0609 BL

Material: Zinc alloy



KL0612 BL

Material: Zinc alloy



KL0613 BL

Material: Zinc alloy

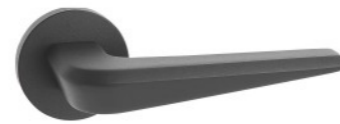

KL0605 BL

Material: Zinc alloy



KL0608 BL

Material: Zinc alloy



KL0606 BL

Material: Zinc alloy



KL0611 BL

Material: Zinc alloy



KL0610 BL

Material: Zinc alloy



KL0617 BL

Material: Zinc alloy



ZINC ALLOY SPLIT SERIES
锌合金分体系列

7X22-X765 MBL

Material: Zinc alloy

Design drawings:

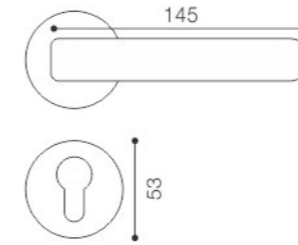

X835-29 MBL

Material: Zinc alloy



X32-X711 SG

Material: Zinc alloy



X32-X60 AB

Material: Zinc alloy



L93-50 PCB

Material: Zinc alloy



X836-11 BL

Material: Zinc alloy



X835-27 BL

Material: Zinc alloy



X50-207 GAG

Material: Zinc alloy



L165-50 AB

Material: Zinc alloy



A02-X52 AB

Material: Zinc alloy



X50-207 CN/CP

Material: Zinc alloy



L165-50 SN

Material: Zinc alloy



A02-X52 SN/CP

Material: Zinc alloy



ZINC ALLOY SPLIT SERIES
 锌合金分体系列

X50-93 SN/CP

Material: Zinc alloy

Design drawings:

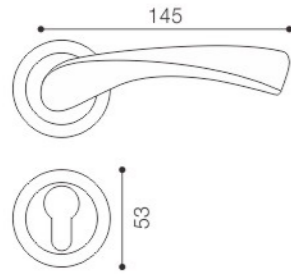

X50-93 SN

Material: Zinc alloy



L169-50 SN/CP

Material: Zinc alloy



L53-50 SN/CP

Material: Zinc alloy



L168-50 SN/CP

Material: Zinc alloy



L167-50 SN/CP

Material: Zinc alloy



A02-L13 CP

Material: Zinc alloy



X96-50 SC/CP

Material: Zinc alloy



L20-50 SN/CP

Material: Zinc alloy



L91-50 AB

Material: Zinc alloy



ZINC ALLOY PANEL SERIES
 锌合金面板系列

F919-M1 SC

Material: Zinc alloy

Design drawings:

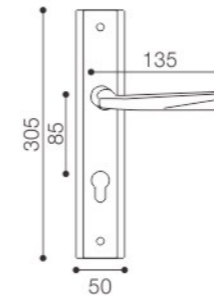

F5888-X08 TBG

Material: Zinc alloy



F5888-X08 AB

Material: Zinc alloy



F5888-X08 AC

Material: Zinc alloy



X804-LJ39 AB

Material: Zinc alloy



F58919-X07 BSN

Material: Zinc alloy



X804-L93 PCB

Material: Zinc alloy



F58919-X07 TBG

Material: Zinc alloy



X804 AB/BL

Material: Zinc alloy

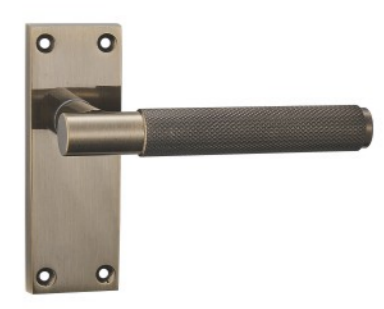

ZINC ALLOY PANEL SERIES
锌合金面板系列

F903-L164 SN

Material: Zinc alloy

Design drawings:

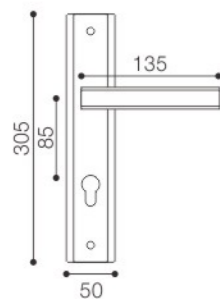

ZINC ALLOY PANEL SERIES
锌合金面板系列

F958/A62 SC

Material: Zinc alloy

Design drawings:

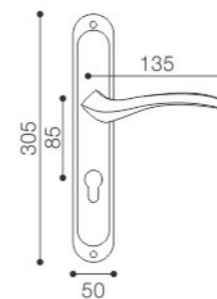

F919/LJ39 SN

Material: Zinc alloy



F919/LJ39 SC

Material: Zinc alloy



F919/LJ39 SN

Material: Zinc alloy



F920-L118 SC

Material: Zinc alloy



F630/61.5 SB

Material: Zinc alloy



F626-L93 AB

Material: Zinc alloy



F58904-L90 SC

Material: Zinc alloy



F58904-P3 SC

Material: Zinc alloy



F919/L164 SN

Material: Zinc alloy



F919-P5 CP

Material: Zinc alloy



F919/LJ39 PCB

Material: Zinc alloy



F785-L230 BN

Material: Zinc alloy



F776-L93 CP

Material: Zinc alloy



F904-P90 SC

Material: Zinc alloy



F633-A48 CP

Material: Zinc alloy



F904-L108 SC

Material: Zinc alloy



ZINC ALLOY PANEL SERIES
 锌合金面板系列

F990-L208 AB
 Material: Zinc alloy

Design drawings:

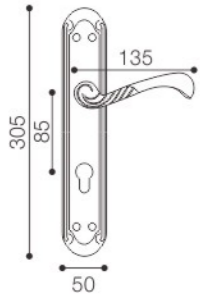

ZINC ALLOY PANEL SERIES
 锌合金面板系列

F941-P3 SC
 Material: Zinc alloy

Design drawings:

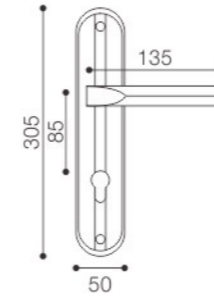

F959-L48 AB
 Material: Zinc alloy

F959-L48 SN
 Material: Zinc alloy

F935/M64 SB
 Material: Zinc alloy

F935/M64 SN
 Material: Zinc alloy



F958-L209 PB
 Material: Zinc alloy

F960-A17 SC
 Material: Zinc alloy

F776-L96 AB
 Material: Zinc alloy



F776-L93 PB
 Material: Zinc alloy

F776-L93 CP
 Material: Zinc alloy

F958-L93 SN
 Material: Zinc alloy

F958-L53 AB
 Material: Zinc alloy



F935-A24 SN
 Material: Zinc alloy

F960-L207 AB
 Material: Zinc alloy

F785-L230 PB
 Material: Zinc alloy



PURE COPPER LOCK Serie

纯铜锁系列



PURE COPPER SPLIT SERIES

纯铜分体系列

BR5-2333 GP

Material: Brass

Design drawings:

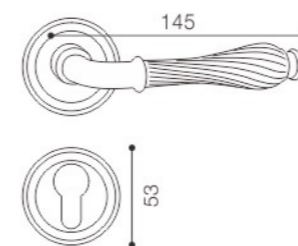

BR5-2333 FBS

Material: Brass



BR5-2333 AH

Material: Brass



BR5-2333 TCF

Material: Brass



BR5-2333 GJ

Material: Brass



BR7-2330 FBS

Material: Brass



BR7-2330 AH

Material: Brass



BR7-2293 TCF

Material: Brass



BR7-2293 AH

Material: Brass



BR7-2293 FBS

Material: Brass



BR5-2301 FBS

Material: Brass



BR5-2301 AH

Material: Brass



BR5-2301 TCF

Material: Brass



PURE COPPER SPLIT SERIES
纯铜分体系列

BR5-2290 FBS

Material: Brass

Design drawings:

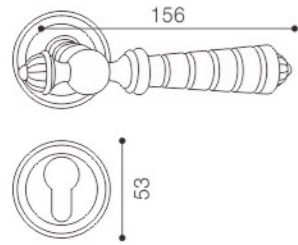

BR5-2290 TCF

Material: Brass



BR5-2290 PVD

Material: Brass



BR5-2290 AH

Material: Brass



BR5-136 FBS

Material: Brass



BR5-136 TCF

Material: Brass



BR5-136 YLS

Material: Brass



BR5-2329 FBS

Material: Brass



BR5-2329 AH

Material: Brass



BR5-2329 TCF

Material: Brass



BR7-2285 AH

Material: Brass



BR7-2285 FBS

Material: Brass



BR7-2285 CP

Material: Brass



PURE COPPER SPLIT SERIES
纯铜分体系列

BR5-153 YLS

Material: Brass

Design drawings:

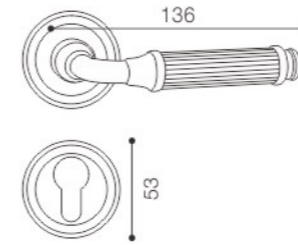

BR5-153 FBS

Material: Brass



BR5-153 PVD

Material: Brass



BR5-153 TCF

Material: Brass



BR7-2297 AH

Material: Brass



BR7-2297 FBS

Material: Brass



BR7-2297 PVD

Material: Brass



BR5-2270 TCF

Material: Brass



BR5-2270 PVD

Material: Brass



BR5-2270 FBS

Material: Brass



BR3-139 MG

Material: Brass



BR3-139 FBS

Material: Brass



BR3-139 TGP

Material: Brass



PURE COPPER SPLIT SERIES
纯铜分体系列

BR3-2298 AH

Material: Brass

Design drawings:

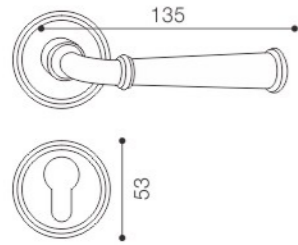

BR3-2298 CP

Material: Brass



BR3-2298 PVD

Material: Brass



BR3-2298 FBS

Material: Brass



BR5-2289 CP

Material: Brass



BR5-2289 PVD

Material: Brass



BR7-2289 AH

Material: Brass



BR7-2317 TCF

Material: Brass



BR7-2317 CP

Material: Brass



BR7-2317 AH

Material: Brass



BR7-2317 FBS

Material: Brass



BR3-137 TGP

Material: Brass



BR3-137 MG

Material: Brass



PURE COPPER SPLIT SERIES
纯铜分体系列

BR7-2283 AH

Material: Brass

Design drawings:

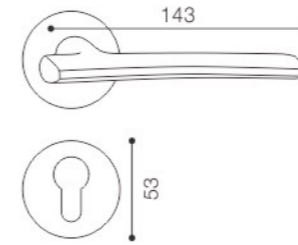

BR7-2283 TCF

Material: Brass



BR7-2283 FBS

Material: Brass



BR7-2283 CP

Material: Brass



BR7-132 MG

Material: Brass



BR7-132 TGP

Material: Brass



BR7-2282 FBS

Material: Brass



BR7-2282 AH

Material: Brass



BR7-2282 CP

Material: Brass



BR7-2282 YLS

Material: Brass



BR3-2278 GP

Material: Brass



BR3-2278 TCF

Material: Brass



BR3-2278 FBS

Material: Brass



PURE COPPER SPLIT SERIES
纯铜分体系列

BR7-2262 YLS

Material: Brass

Design drawings:

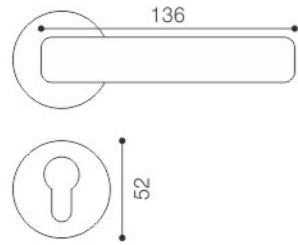

BR7-2262 TCF

Material: Brass



BR7-2262 FBS

Material: Brass



BR7-2262 AH

Material: Brass



BR7-157 AH

Material: Brass



BR7-157 XBJ

Material: Brass



BR7-157 YLS

Material: Brass



BR3-135 TCF

Material: Brass



BR3-135 FBS

Material: Brass



BR3-135 AH

Material: Brass



BR7-152 TCF

Material: Brass



BR7-152 CP

Material: Brass



BR7-152 AH

Material: Brass



PURE COPPER SPLIT SERIES
纯铜分体系列

BR5-123 FBS

Material: Brass

Design drawings:

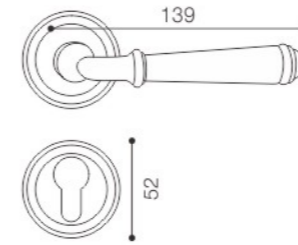

BR5-123 TCF

Material: Brass



BR5-123 PVD

Material: Brass



BR5-123 AH

Material: Brass



BR7-122 PVD

Material: Brass



BR7-122 FB

Material: Brass



BR7-122 TCF

Material: Brass



BR7-122 AH

Material: Brass



BR5-2277 PVD

Material: Brass



BR5-2277 CP

Material: Brass



BR5-2311 TCF

Material: Brass



BR5-2276 PVD

Material: Brass



BR5-2276 CP

Material: Brass



PURE COPPER SPLIT SERIES
纯铜分体系列

BR9-85 MG

Material: Brass

Design drawings:

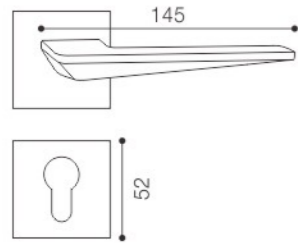

BR9-85 TCF

Material: Brass

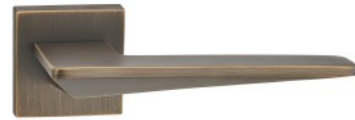

BR9-85 FBS

Material: Brass



BR9-85 YLS

Material: Brass



BR9-2291 AH

Material: Brass



BR9-2291 FBS

Material: Brass



BR9-2291 AH

Material: Brass



BRX9-193 FBS

Material: Brass



BRZ9-95 TCF

Material: Brass



BR9-71 FBS

Material: Brass



BRX9-193 TCF

Material: Brass



BRZ9-95 FBS

Material: Brass



BR9-71 TCF

Material: Brass



PURE COPPER PANEL SERIES
纯铜面板系列

85BR20197-2290 GP

Material: Brass

Design drawings:

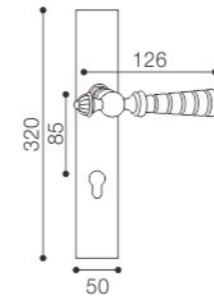

85BR20197-2290 FBS

Material: Brass



BR38-85 MG

Material: Brass



BR38-85 TCF

Material: Brass



BR38-85 YLS

Material: Brass



BR20193-193 FBS

Material: Brass



BR20193-193 TCF

Material: Brass



BR20187-95 TCF

Material: Brass



BR20187-95 FBS

Material: Brass



PURE COPPER PANEL SERIES

纯铜面板系列

85BR2311-2311 FBS

Material: Brass

Design drawings:

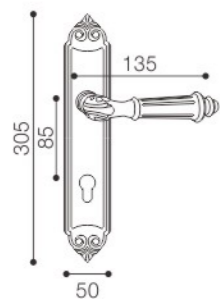

85BR2311-2311 TCF

Material: Brass



BR20196-2278 GP

Material: Brass



BR20196-2278 TCF

Material: Brass



BR20196-2278 FBS

Material: Brass



BR20195-2277 PVD

Material: Brass



BR20195-2277 CP

Material: Brass



BR20195-2276 CP

Material: Brass



BR20195-2276 PVD

Material: Brass



PURE COPPER HINGE SERIES

纯铜合页系列



BR505-TCF



BR508 FBS



BR505-CF



BR508 AH

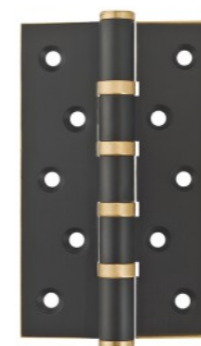

BR503 CF



BR503 FBS



BR503 TLS



BR503 TCF



BR405-TCF



BR405-CF



BR408 FBS



BR408 AH



BR403 CF



BR403 TLS



BR403 FBS



BR403 TCF

PURE COPPER DOOR STOP SERIES
纯铜门吸系列



BR881 TLS



BR881 PVD



BR881 CP



BR881 FBS



BR881 CF



BR881 TCF



BR881 MG



BR881 AH



BR-889 YLS



BR-889 TCF



BR-889 CF



BR-892 AH



BR892 FBS



BR-892 TCF



BR-892 CF



BR892 CP

STAINLESS STEEL SERIES
不锈钢系列

双弯 SN

Material: Stainless steel

Design drawings:

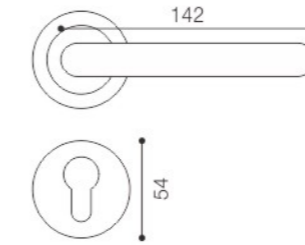

单弯 SN

Material: Stainless steel



直弯 SN

Material: Stainless steel



912 SN

Material: Stainless steel



908 SN

Material: Stainless steel



219 SN

Material: Stainless steel



192 SN

Material: Stainless steel



197 SN

Material: Stainless steel



236 SN

Material: Stainless steel



182 SN

Material: Stainless steel



228 SN

Material: Stainless steel



226 SN

Material: Stainless steel



909 SN

Material: Stainless steel



STAINLESS STEEL SERIES

不锈钢系列

185 SN

Material: Stainless steel

Design drawings:

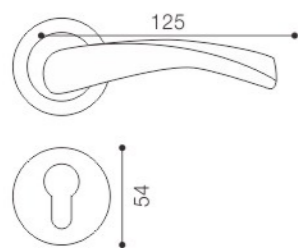

STAINLESS STEEL SERIES

不锈钢系列

228 BL

Material: Stainless steel

Design drawings:

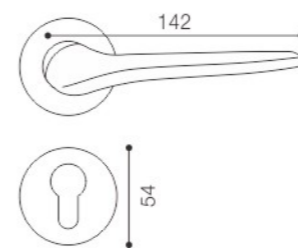

193 SN

Material: Stainless steel



213 SN

Material: Stainless steel



202 SN

Material: Stainless steel



223 SN

Material: Stainless steel



916 SN

Material: Stainless steel



217 SN

Material: Stainless steel



223 BL

Material: Stainless steel



219 BL

Material: Stainless steel



197 BL

Material: Stainless steel



217 BL

Material: Stainless steel



912 BL

Material: Stainless steel



202 BL

Material: Stainless steel



226 BL

Material: Stainless steel



228 SB

Material: Stainless steel



223 SB

Material: Stainless steel



236 SB

Material: Stainless steel



217 SB

Material: Stainless steel



912 SB

Material: Stainless steel



226 SB

Material: Stainless steel



197 SB

Material: Stainless steel



202 SB

Material: Stainless steel



228 AB

Material: Stainless steel



223 AB

Material: Stainless steel



219 AB

Material: Stainless steel



STAINLESS STEEL SERIES
不锈钢系列

912 AB
Material: Stainless steel
Design drawings:

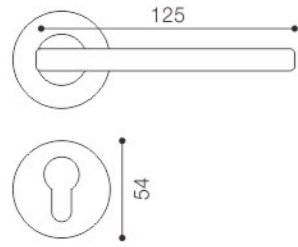

217 AB
Material: Stainless steel



202 AB
Material: Stainless steel



197 AB
Material: Stainless steel



226 AB
Material: Stainless steel



228 AC
Material: Stainless steel



223 AC
Material: Stainless steel



236 AC
Material: Stainless steel



217 AC
Material: Stainless steel



912 AC
Material: Stainless steel



202 AC
Material: Stainless steel



226 AC
Material: Stainless steel



197 AC
Material: Stainless steel



极简生态门锁
Minimalist ecological door lock

极简生态锁

是一款集现代设计美学与智能技术于一体的安防产品。它使用环保材料和简单的结构，重新定义了家庭安全体验。

Minimalist ecological lock

It is a security product that integrates modern design aesthetics with intelligent technology. It uses eco-friendly materials and a simple structure, redefining the home security experience.

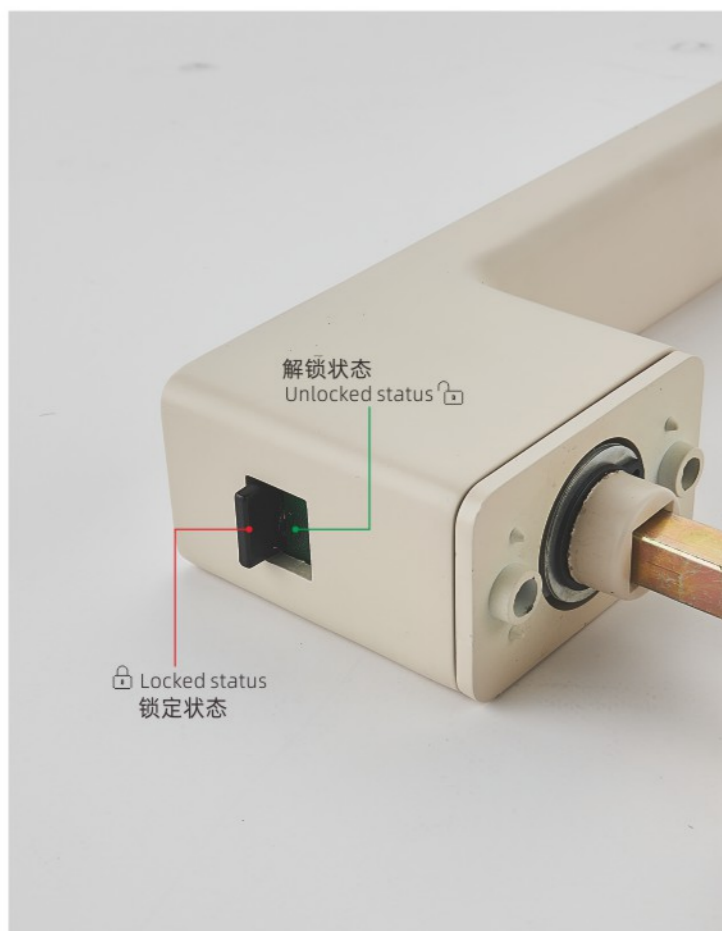

K20 OW
Material: Zinc alloy

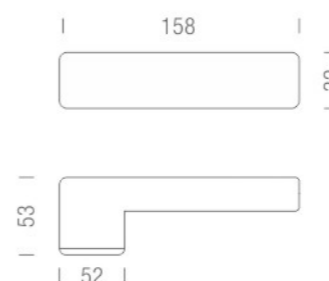

PRODUCT COLOR



OW



BBL



BGR



K20 SG
Material: Zinc alloy



PRODUCT COLOR



SG



K-21

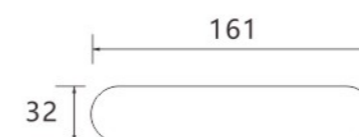
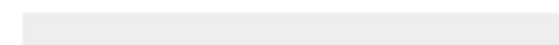

FINISHES AVAILABLE

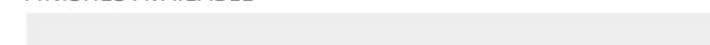

BL



GRAY



WH

Material: Zinc alloy

*Door Thickness: 38-50mm

K-29/BK

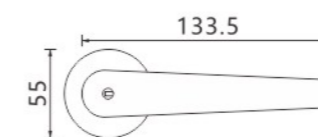

FINISHES AVAILABLE



BL



GRAY



PVD



SG

Material: Zinc alloy

*Door Thickness: 38-50mm

K-31/BK

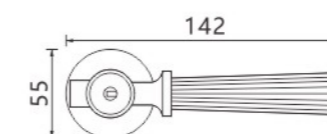

FINISHES AVAILABLE



BL



GRAY



PVD



SG

Material: Zinc alloy

*Door Thickness: 38-50mm

K-41



FINISHES AVAILABLE

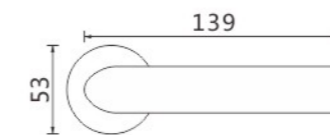

BL



GRAY



SS

Material: Zinc alloy

*Door Thickness: 38-50mm

K-32/BK

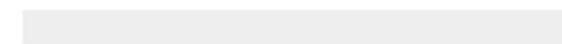

FINISHES AVAILABLE



BL



GRAY

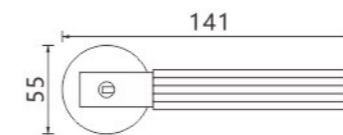

PVD



SG

Material: Zinc alloy

*Door Thickness: 38-50mm

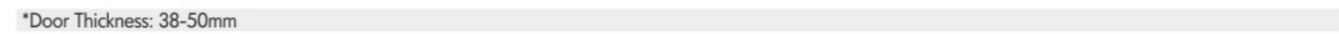

HYDRAULIC HINGE SERIES

液压合页系列

3D-90-18-10088L

Hidden hinge

上下调节: $\pm 2\text{mm}$
Vertical $\pm 2\text{mm}$
左右调节: $\pm 2\text{mm}$
Horizontal $\pm 2\text{mm}$
前后调节: $\pm 1.5\text{mm}$
Depth $\pm 1.5\text{mm}$
开口角度: 180度
Opening angle: 180°
3个合页的最大承重12kg
Max. door weight with 3 hinges 12kg
最小门厚23mm
Min. door thickness 23mm
最大门宽600mm
Max. door width 600mm
最大门高1500mm
Max. door high 1500mm

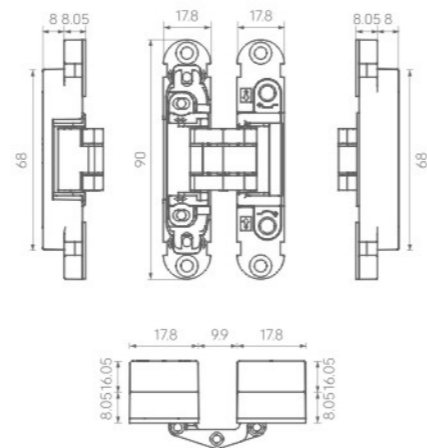

3D-110-30-6888

Hidden hinge

上下调节: $\pm 2\text{mm}$
Vertical $\pm 2\text{mm}$
左右调节: $\pm 2\text{mm}$
Horizontal $\pm 2\text{mm}$
前后调节: $\pm 1.5\text{mm}$
Depth $\pm 1.5\text{mm}$
开口角度: 180度
Opening angle: 180°
3个合页的最大承重40kg
Max. door weight with 3 hinges 40kg
最小门厚40mm
Min. door thickness 40mm
最大门宽940mm
Max. door width 940mm
最大门高2286mm
Max. door high 2286mm

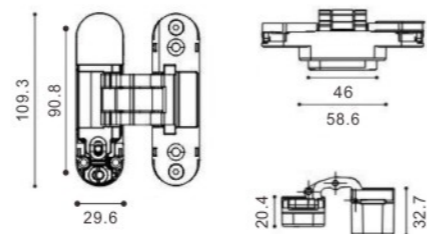

3D-115-23-6899

Hidden hinge

上下调节: $\pm 2\text{mm}$
Vertical $\pm 2\text{mm}$
左右调节: $\pm 2\text{mm}$
Horizontal $\pm 2\text{mm}$
前后调节: $\pm 1.5\text{mm}$
Depth $\pm 1.5\text{mm}$
开口角度: 180度
Opening angle: 180°
3个合页的最大承重40kg
Max. door weight with 3 hinges 40kg
最小门厚26mm
Min. door thickness 26mm
最大门宽940mm
Max. door width 940mm
最大门高2286mm
Max. door high 2286mm

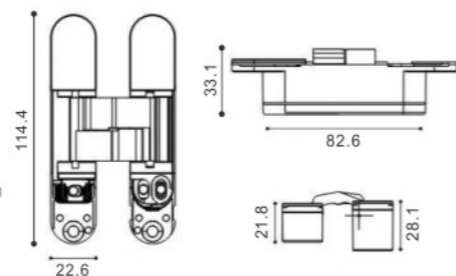

HYDRAULIC HINGE SERIES

液压合页系列

3D-120-23-6915

Hidden hinge

上下调节: $\pm 2\text{mm}$
Vertical $\pm 2\text{mm}$
左右调节: $\pm 1\text{mm}$
Horizontal $\pm 2\text{mm}$
前后调节: $\pm 1\text{mm}$
Depth $\pm 1.5\text{mm}$
开口角度: 180度
Opening angle: 180°
3个合页的最大承重60kg
Max. door weight with 3 hinges 60kg
最小门厚30mm
Min. door thickness 30mm
最大门宽960mm
Max. door width 960mm
最大门高2490mm
Max. door high 2490mm

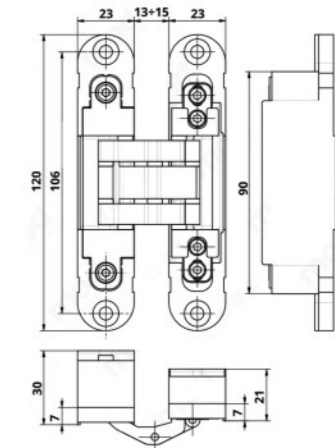

3D-120-30-6877

Hidden hinge

上下调节: $\pm 2\text{mm}$
Vertical $\pm 2\text{mm}$
左右调节: $\pm 2\text{mm}$
Horizontal $\pm 2\text{mm}$
前后调节: $\pm 1.5\text{mm}$
Depth $\pm 1.5\text{mm}$
开口角度: 180度
Opening angle: 180°
3个合页的最大承重60kg/80kg
Max. door weight with 3 hinges 60kg/80kg
最小门厚40mm
Min. door thickness 40mm
最大门宽940mm
Max. door width 940mm
最大门高2286mm
Max. door high 2286mm

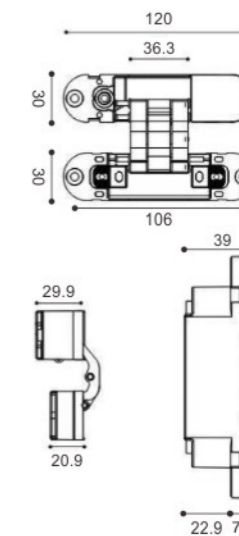

3D-135-28-6903

Hidden hinge

上下调节: $\pm 2\text{mm}$
Vertical $\pm 2\text{mm}$
左右调节: $\pm 2\text{mm}$
Horizontal $\pm 2\text{mm}$
前后调节: $\pm 1.5\text{mm}$
Depth $\pm 1.5\text{mm}$
开口角度: 180度
Opening angle: 180°
3个合页的最大承重60kg
Max. door weight with 3 hinges 60kg
最小门厚38mm
Min. door thickness 38mm
最大门宽900mm
Max. door width 900mm
最大门高2300mm
Max. door high 2300mm

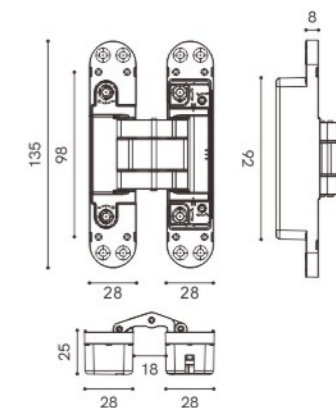

HYDRAULIC HINGE SERIES
液压合页系列



3D-150-31-6855

Hidden hinge

上下调节: ±3mm
Vertical ± 3mm
左右调节: ±2mm
Horizontal ± 2mm
前后调节: ±1mm
Depth ± 1mm
开口角度: 180度
Opening angle: 180°
3个合页的最大承重80kg
Max. door weight with 3 hinges 80kg
最小门厚40mm
Min. door thickness 40mm
最大门宽940mm
Max. door width 940mm
最大门高2286mm
Max. door high 2286mm

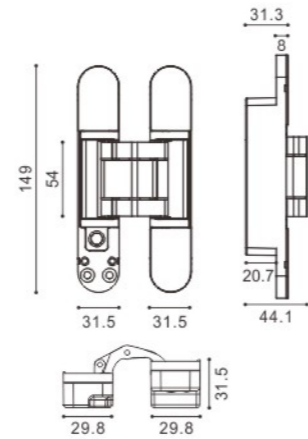

CH40

SW-001 隐藏式铰链

材质 锌合金
可承载最大门重 40/60/80KG(2个)
门厚 40-60mm
三维可调参数 前后方向±1.0mm
上下方向±2.5mm
左右方向±1.5mm

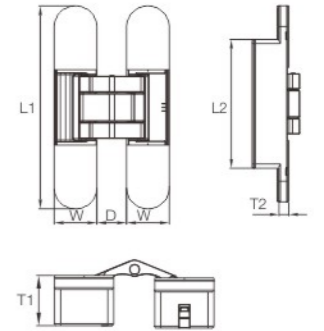

规格	L1	L2	W	D	T1	T2
40KG	130	88	25	15	19	6
60KG	135	92	28	18	25	7
80KG	150	106	32	19	31	14

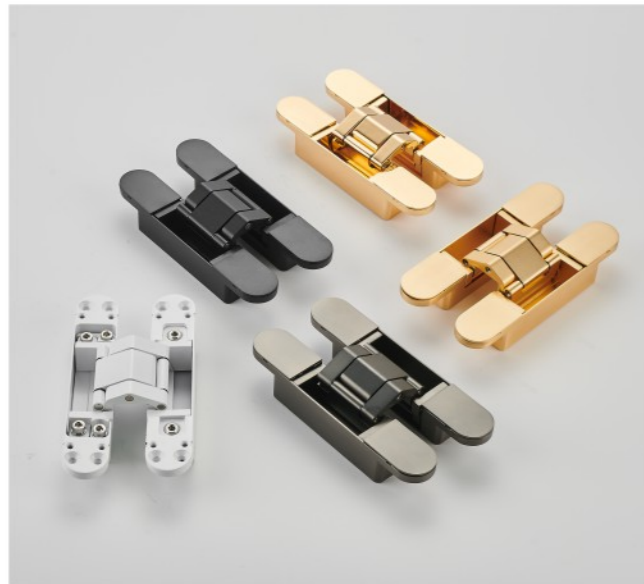

3D-165-30-6905

Hidden hinge

上下调节: ±2mm
Vertical ± 2mm
左右调节: ±1.5mm
Horizontal ± 1.5mm
前后调节: ±1mm
Depth ± 1mm
开口角度: 180度
Opening angle: 180°
3个合页的最大承重80kg
Max. door weight with 3 hinges 80kg
最小门厚45mm
Min. door thickness 45mm
最大门宽940mm
Max. door width 940mm
最大门高2286mm
Max. door high 2286mm

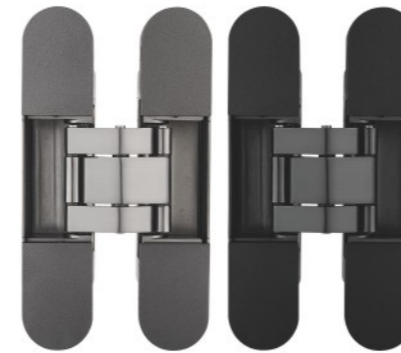
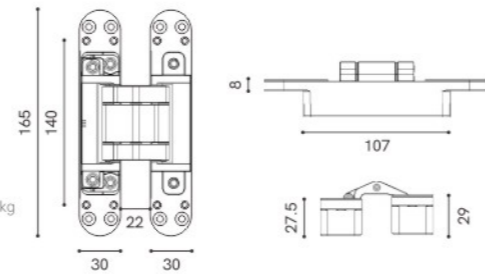

CH60



3D-130-25/32-6907

Hidden hinge

上下调节: ±2mm
Vertical ± 2mm
左右调节: ±2mm
Horizontal ± 2mm
前后调节: ±1.5mm
Depth ± 1.5mm
开口角度: 180度
Opening angle: 180°
3个合页的最大承重60kg
Max. door weight with 3 hinges 60kg
最小门厚40mm
Min. door thickness 40mm
最大门宽940mm
Max. door width 940mm
最大门高2286mm
Max. door high 2286mm

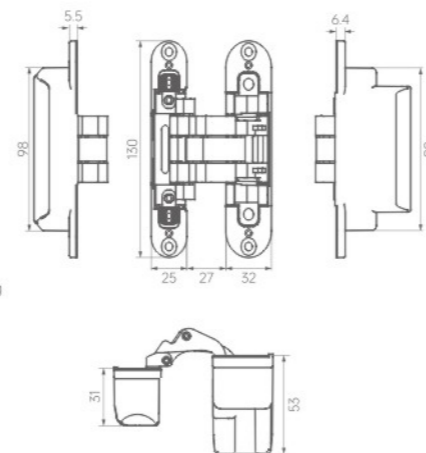

CH80



LOCK CORE SERIES
锁芯系列



Z7008 SN



L7008 SN



Z7006 PB



7006 SN



L7006 SN



7006 BN



L7006 PB



L7006 CP



7006 PB



7006 BS



9008 CP



9008 SN



P7003 SN-C05



P7003 SB-C05



P7003 BL-C05

LOCK CORE SERIES
锁芯系列



6008 AB



6008 PB



6008 GP



6008 SN



6008 BS



6008 MSN



7008 SN



7008 AB



7008 SB



Z7008 SN



L9008 CP



L10508 CP

LOCK CORE SERIES
锁芯系列



7012 SB-G



7012 BL-K



7012 BL-E



7012 SN-X2



7012 YB-Y1



7012 BN-Y1



7012 AB-Y1



7012 AB-M



7012 SB-Y4



7012 CP-H



7012 PB-H



7012 BL-H



7012 SC-H



7012 BL-H1



7503 SN-H



7503 SN-C08-H

LOCK CORE SERIES
锁芯系列



7512 BN-H



7512 BL-H



7212 BL-H



L7512 SN-B



L7012 SN-H



L7012 SN-H



L7012 SN-B



6012 SB-A06 E



7028 BL-G



7028 BL-H



7028 SN-H



7028 BL-G



9012 BN-E



9012 AB-E



9012 CP-C



9012 SN-H



8520 SS



8525 SS



8530 SS



8535 SS



8550 SB



8550 SS



8550 SS



8560 SS



8535 SN



8540 SN



8540 SN



8540 AC



8545 AB



8545 PB



8545 SS



8545 SN



8545 SN



8545 PB



8545 AC



8545 AB



8545 SS



8545 SN



8545 SS



8545 SN

LOCK SYSTEM SERIES
锁体系列



8545 SS



8545 SS



8545-10 SN



8545 MSN



8545 BL



7255 SS



7255 SS



5845 SS



5845 AC



5845 PB



5845 SN



5845 SN

LOCK SYSTEM SERIES
锁体系列



5845 YB-3



5845 BL-3



5845 PVD-36



5845 AB-3



5845-16 SS



5845-10 SS



5845-12 SS



5845 SS



5845 SS



欧标
European Standard



欧标
European Standard



美标
American standard

LOCK CORE SERIES
锁芯系列

HINGE SERIES
合页系列



A01



A02



A03



A04



A05



A06



A07



A08



A10



C05



A050



A051



63.54 SS



63.54 SS



553 SS



4.5x4.5x3 SS



553 SS



643.5 SS



643.5 SS



4.5x4.5x3 SS



543 平开-PB



553 平开-PB



553 平开-YB



53.53 平开-YB



63.53 平开-YB



533 子母-SS



533 子母-SS



433 子母-AB



533 子母-YB



433 子母-SS



533 子母-AB



533 子母-PB

HINGE SERIES
合页系列



843.5 平开-BL



843.5 SS



643 平开-BL



643 平开-YB



643 平开-PB



553 平开-AB



553 平开-PB



553 平开-AC



63.53 平开-BL



843.5 SS



4.54.53 平开-AB



4.543 平开-BL



4.54.53 平开-GN



4.543 平开-YB



443 平开-SS



4.543 平开-GN



443 平开-AB

HINGE SERIES
合页系列



443 平开-YB



443 平开-BL



443 平开-AC



443 SS



533 平开-YB



533 平开-GN



533 平开-AC



533 平开-PB



443 平开-YB



43.53 平开-BL

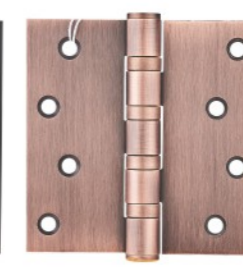

43.53 平开-AC



43.53 平开-AB



4.5x4.5x3 SS



43.53 平开-AB



433 平开-BL



433 平开-AC



43.53 平开-GN



4.5x4.5x3 SS

FLOOR SUCTION/DOOR SUCTION SERIES
地吸\门吸系列



209 SN 209 SPG 209 YB 209 BL 209 SG



1328 YB 1328 BL 1328 SG 1328 SPG 1328 AB



1328 SN 1328 PVD 215 SN 215 SPG 215 SG



215 BL 220 SN 220 SPG 220 YB 220BL

FLOOR SUCTION/DOOR SUCTION SERIES
地吸\门吸系列



270 SPG 270 SN 270 BL 270 SG 270 PVD



280 YB 280 BL 280 SG 280 SPG 280 SN



271 SG 271 CP 271 WH 271 AB 271 SN



271 PVD 272 YB 272 SN 272 SPG 272 BL

VILLA LOCK SERIES

別墅鎖系列



<p>9805XL-02双拉 亚光青古铜 Matte Bronze</p>	<p>9805XL-02双拉 亚光红古铜 Matte red Antique Copper</p>	<p>9805XL-02双拉 亮镍拉丝 Shiny Nickel</p>
<p>9805XL-02单拉 亮镍拉丝 Shiny Brushed Nickel</p>	<p>9805XL-02单拉 亚光青古铜 Matte Bronze</p>	<p>9805XL-02单拉 亚光红古铜 Matte Red Antuque Copper</p>

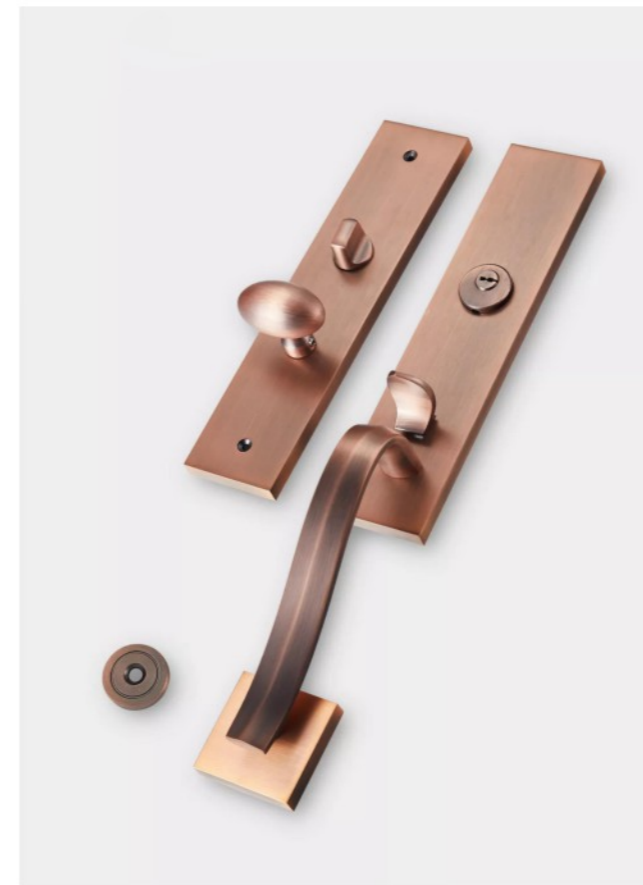

<p>9809M-06单拉 黑红古 Black Brass</p>	<p>9809M-06单拉 黄古铜 Yellow Brass</p>
<p>9809M-06单拉 亮镍拉丝 Shiny brushed Nickel</p>	<p>9809M-06单拉 亚光红古铜 Matte Brass</p>



<p>9809XL-06双拉 黑红古 Black Brass</p>	<p>9809XL-06双拉 黄古铜 Yellow Brass</p>	<p>9809XL-06双拉 亮镍拉丝 Shiny Nickel</p>	<p>9809XL-06双拉 亚光红古铜 Matre Brass</p>
<p>9809L-06单拉 黑红古 Black Brass</p>	<p>9809L-06单拉 黄古铜 Yellow Brass</p>	<p>9809L-06单拉 亮镍拉丝 Shinyn Brushed ickel</p>	<p>9809L-06单拉 亚光红古铜 Matte Brass</p>



<p>9801XL-01双拉 黄古铜 Yellow Brass</p>	<p>9801XL-01双拉 亚光红古铜 Matte Brass</p>	<p>9801XL-01双拉 亚光青古铜 Matte Bronze</p>
<p>9801L-01单拉 亮镍拉丝 Shiny Brushed Nickel</p>	<p>9801L-01单拉 亮镍拉丝 Shiny Brushed Nickel</p>	<p>9801L-01单拉 亚光红古铜 Matte Brass</p>

VILLA LOCK SERIES

別墅鎖系列

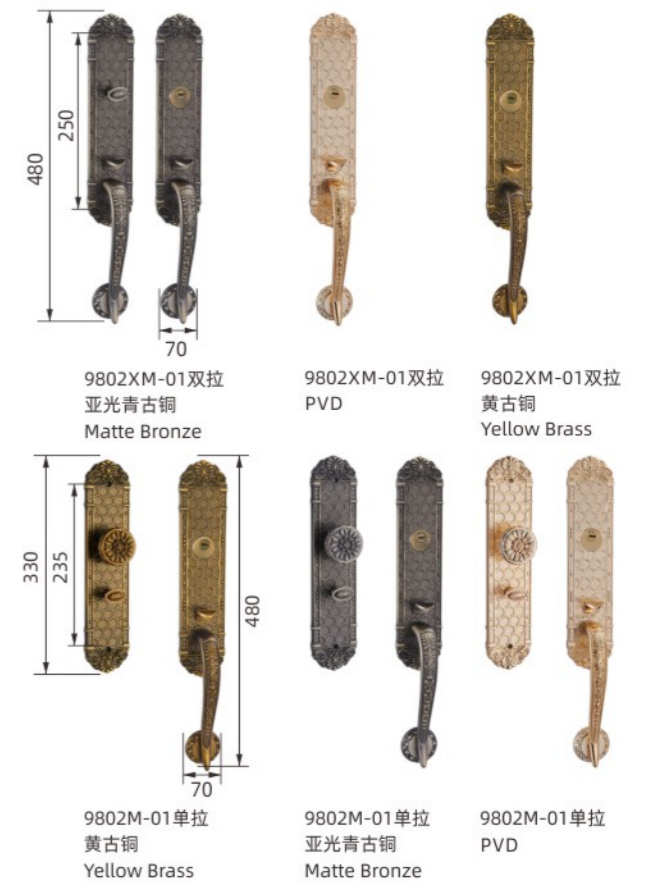
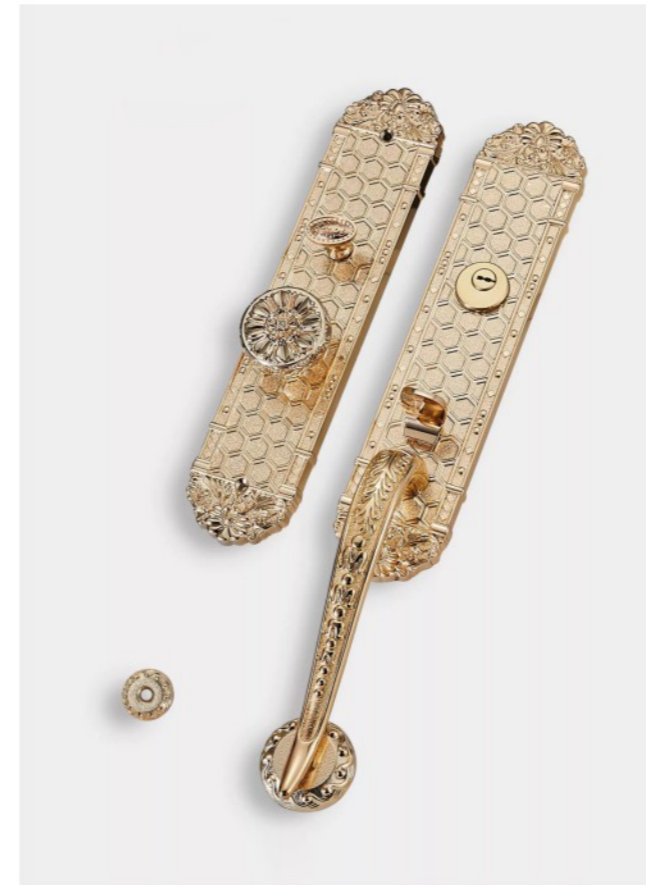
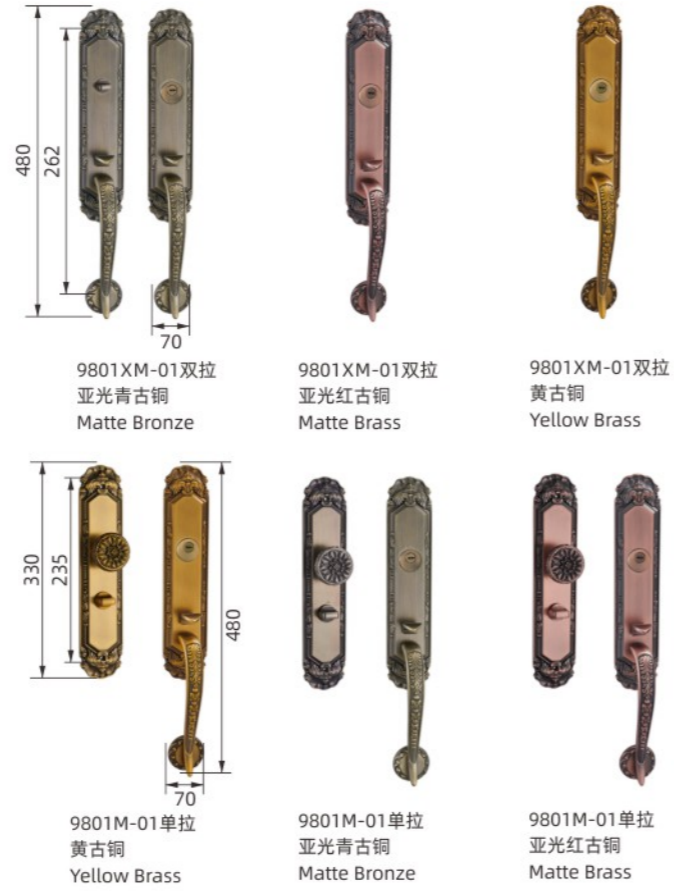
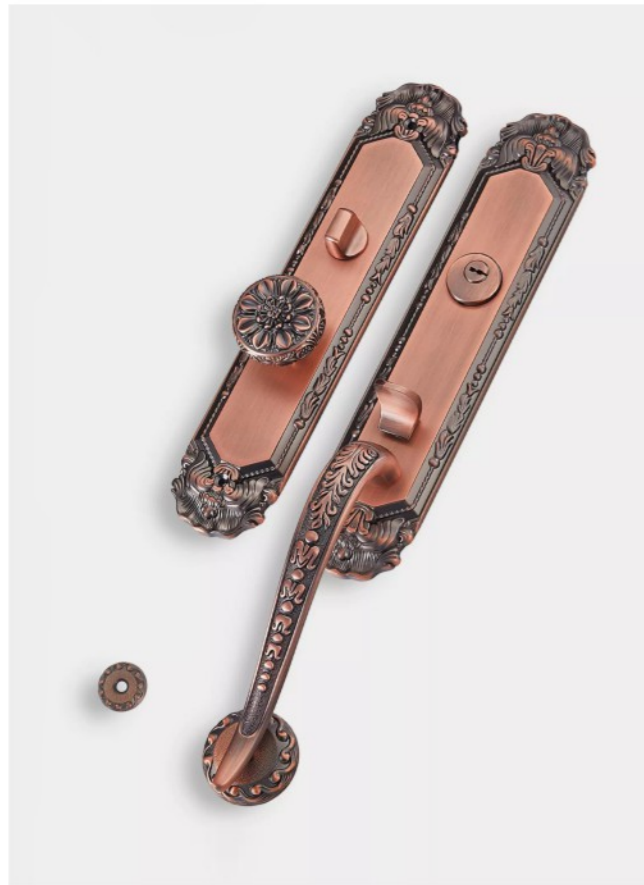

VILLA LOCK SERIES

別墅鎖系列

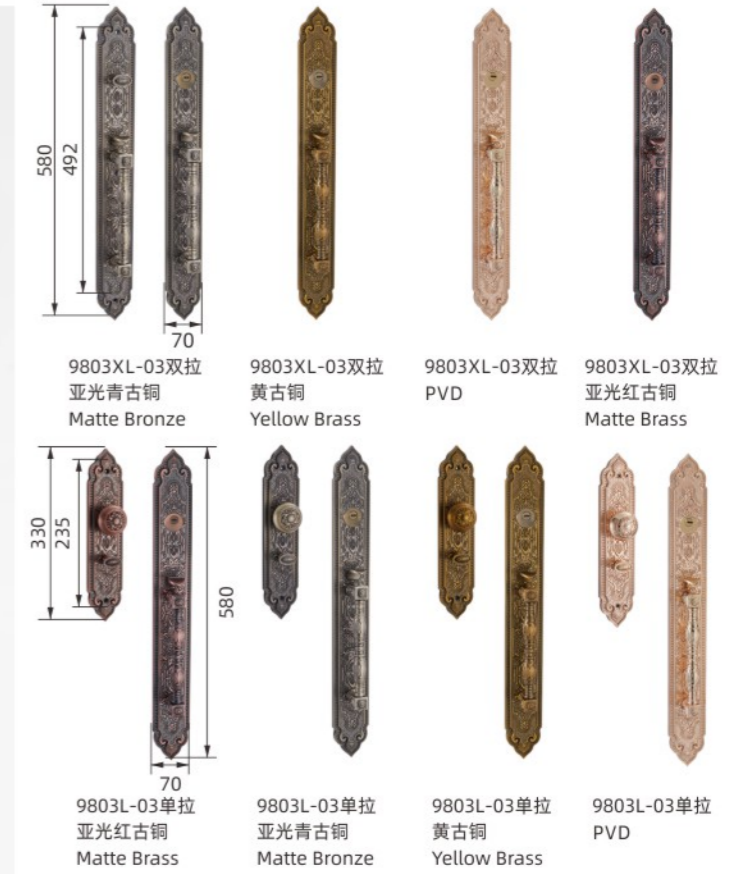
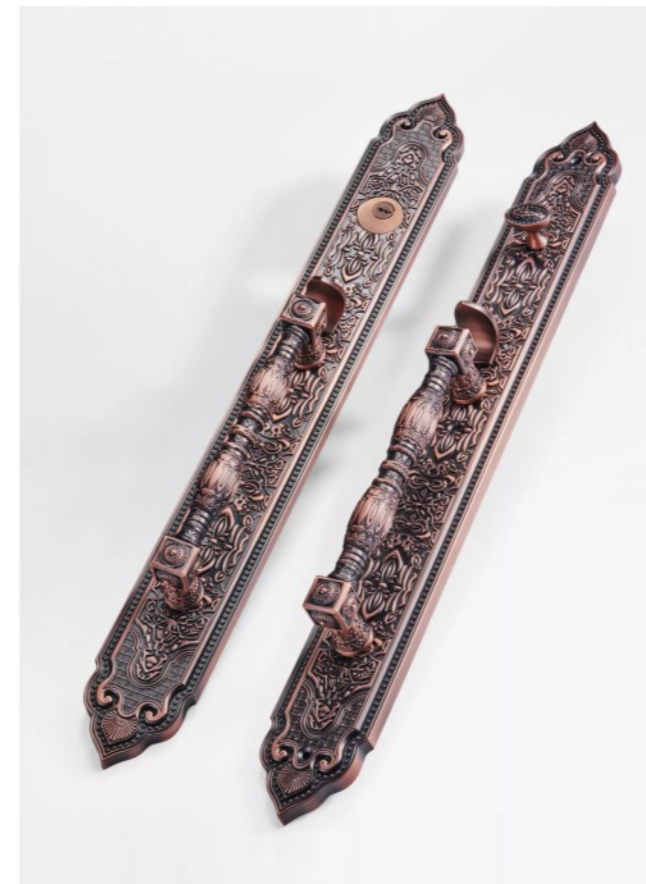
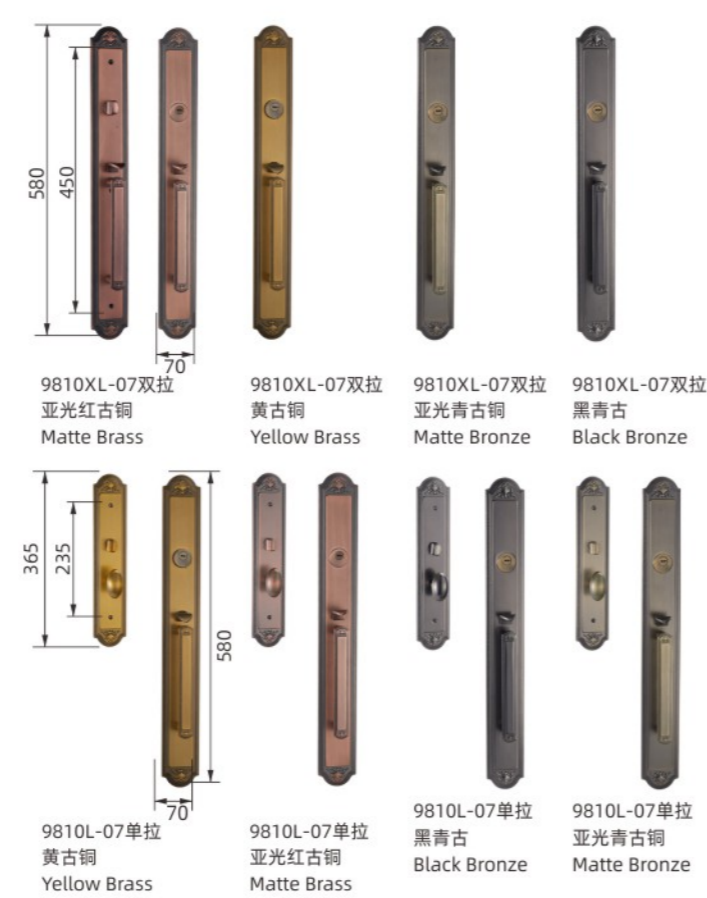

VILLA LOCK SERIES

別墅鎖系列

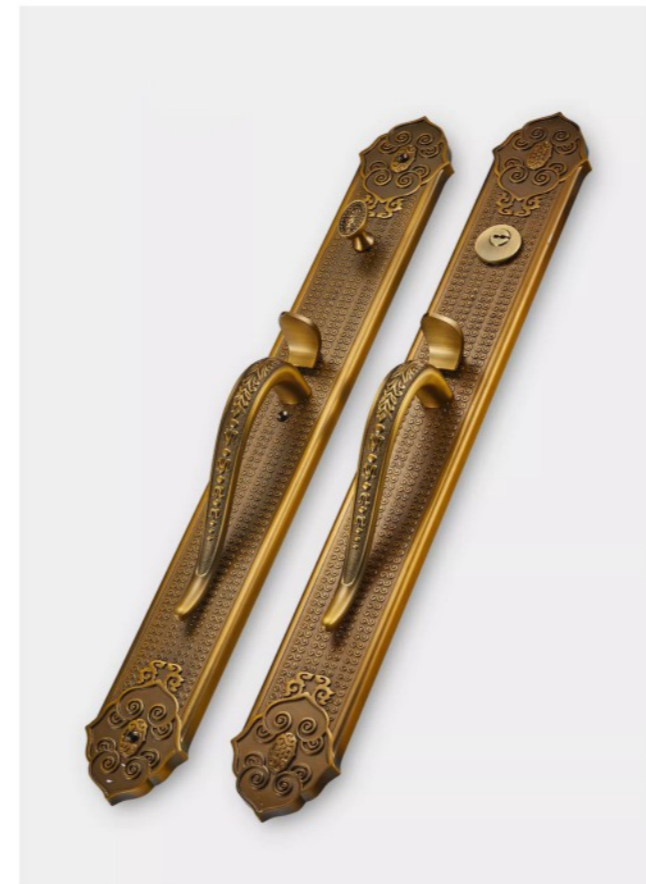
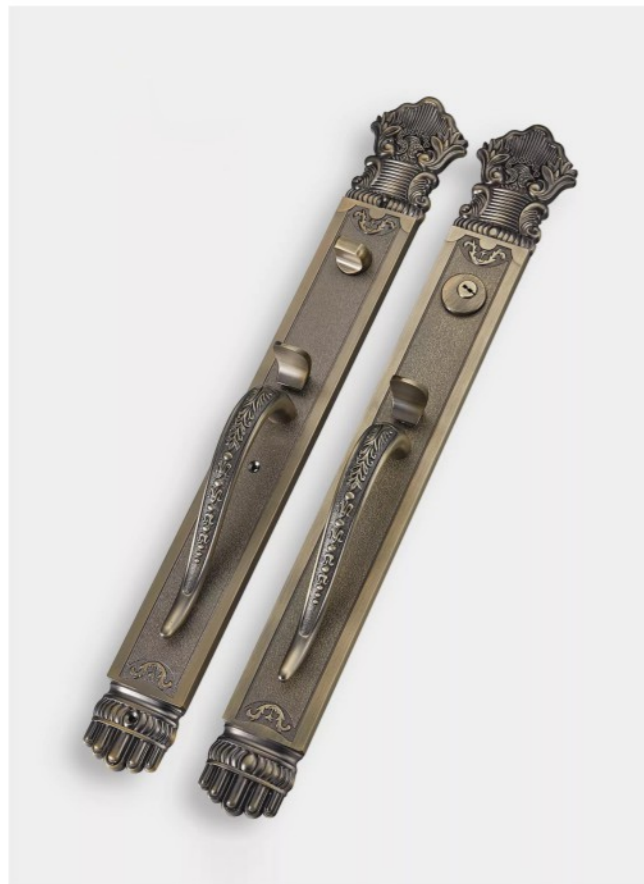
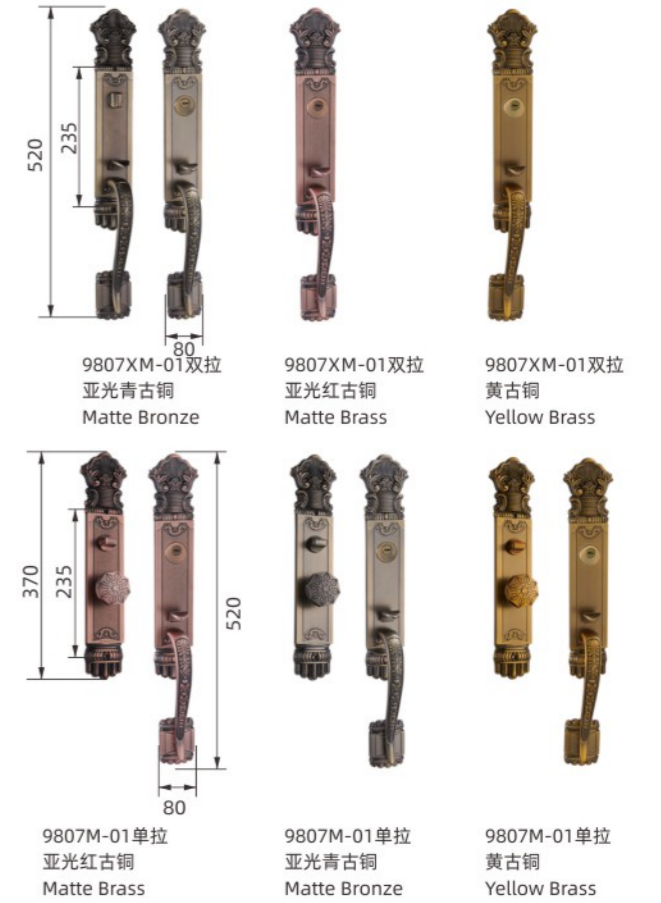
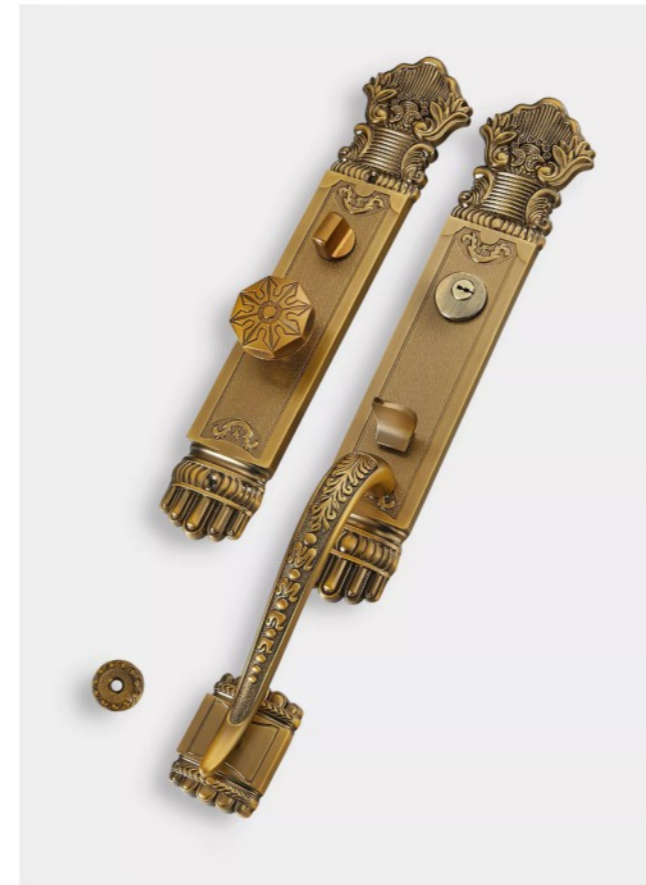
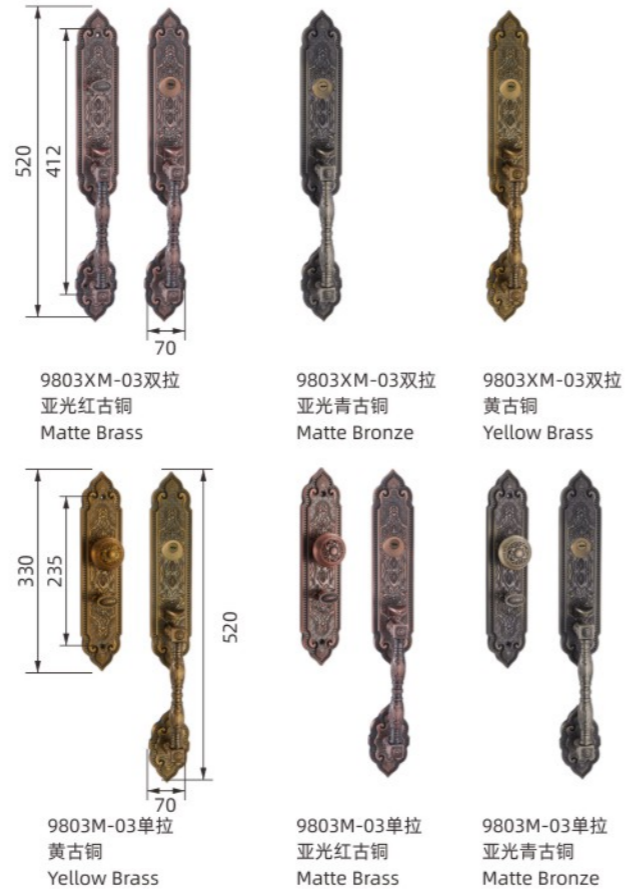
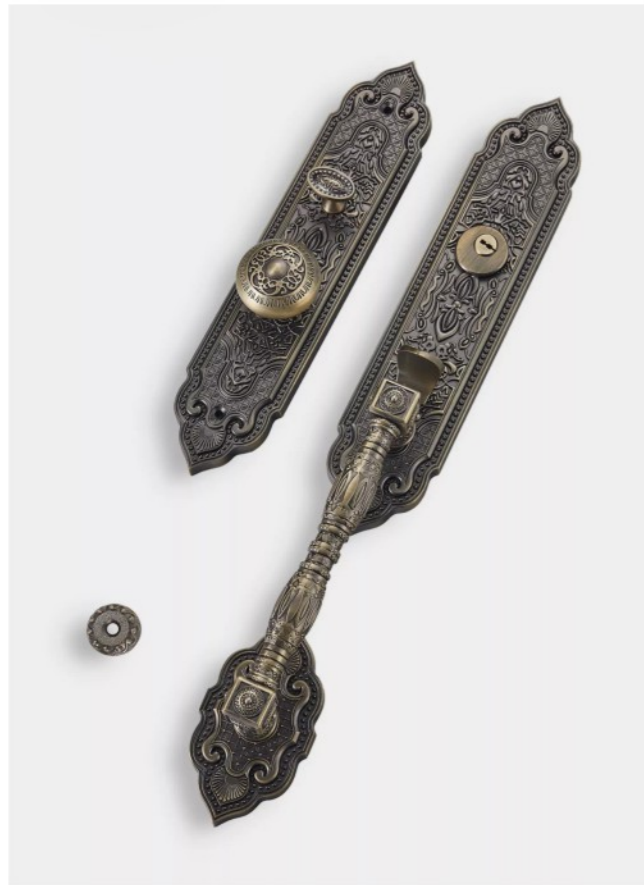

VILLA LOCK SERIES

別墅鎖系列

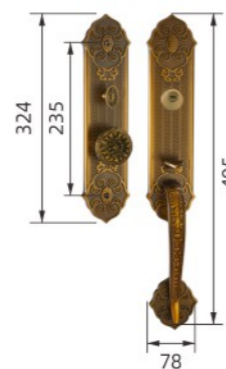
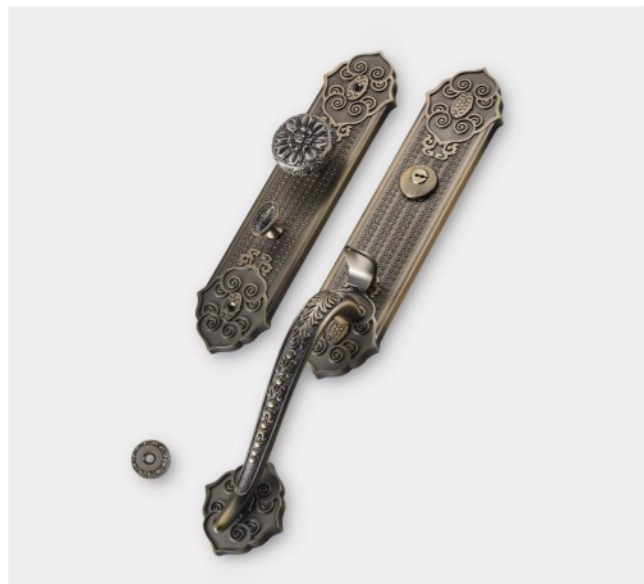

9808M-01单拉
黄古铜
Yellow Brass



9808M-01单拉
亚光红古铜
Matte Brass



9808M-01单拉
亚光青古铜
Matte Bronze

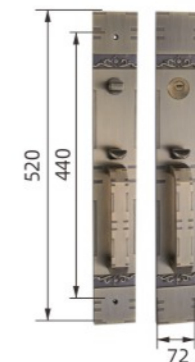
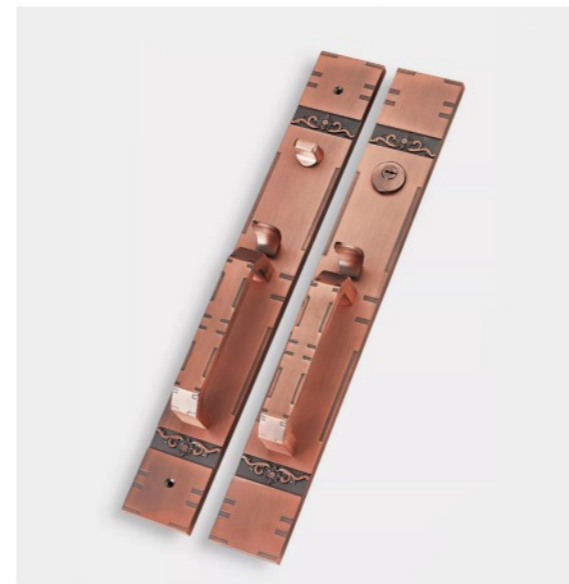

9806XL-05双拉
亚光青古铜
Matte Bronze



9806XL-05双拉
亚光红古铜
Matte Red Antique Copper



9806XL-05双拉
黄古铜
Yellow Brass



9810M-07单拉
黑青古
Black Bronze



9810M-07单拉
亚光青古铜
Matte Bronze



9810M-07单拉
亚光红古铜
Matte Brass



9810M-07单拉
黄古铜
Yellow Brass

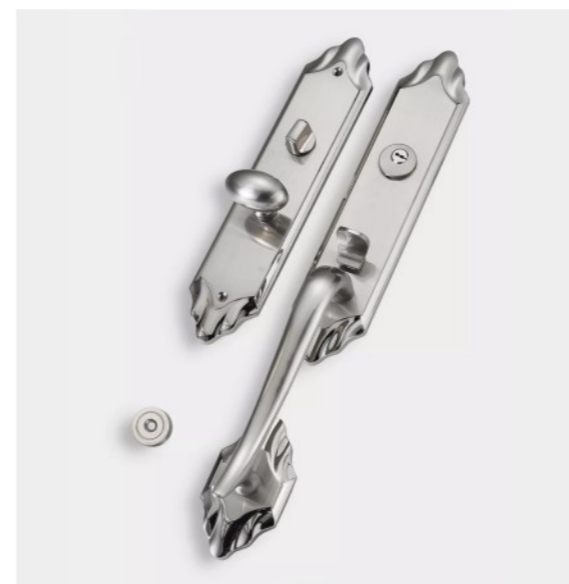

9805M-02单拉
亮铬拉丝
Shiny Brushed Chrome



9805M-02单拉
亚光青古铜
Matte Bronze



9811XL-D08
PVD



9811XL-D08
亚光青古铜
Matte Bronze



9811XL-D08
黑红古
Black Brass

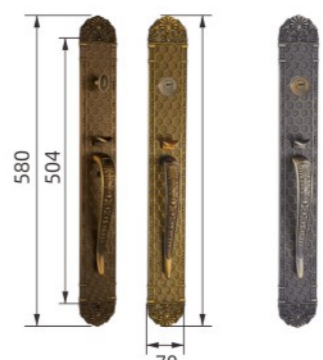

9802XL-01双拉
黄古铜
Yellow Brass



9802XL-01双拉
亚光青古铜
Matte Bronze

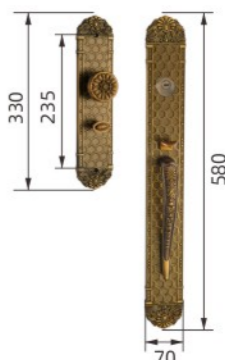

9802L-01单拉
黄古铜
Yellow Brass



9802L-01单拉
亚光青古铜
Matte Bronze

VILLA LOCK SERIES

別墅鎖系列

